

School Bus Rider Safety Book

SAFE DAYS

with Oliver Owl

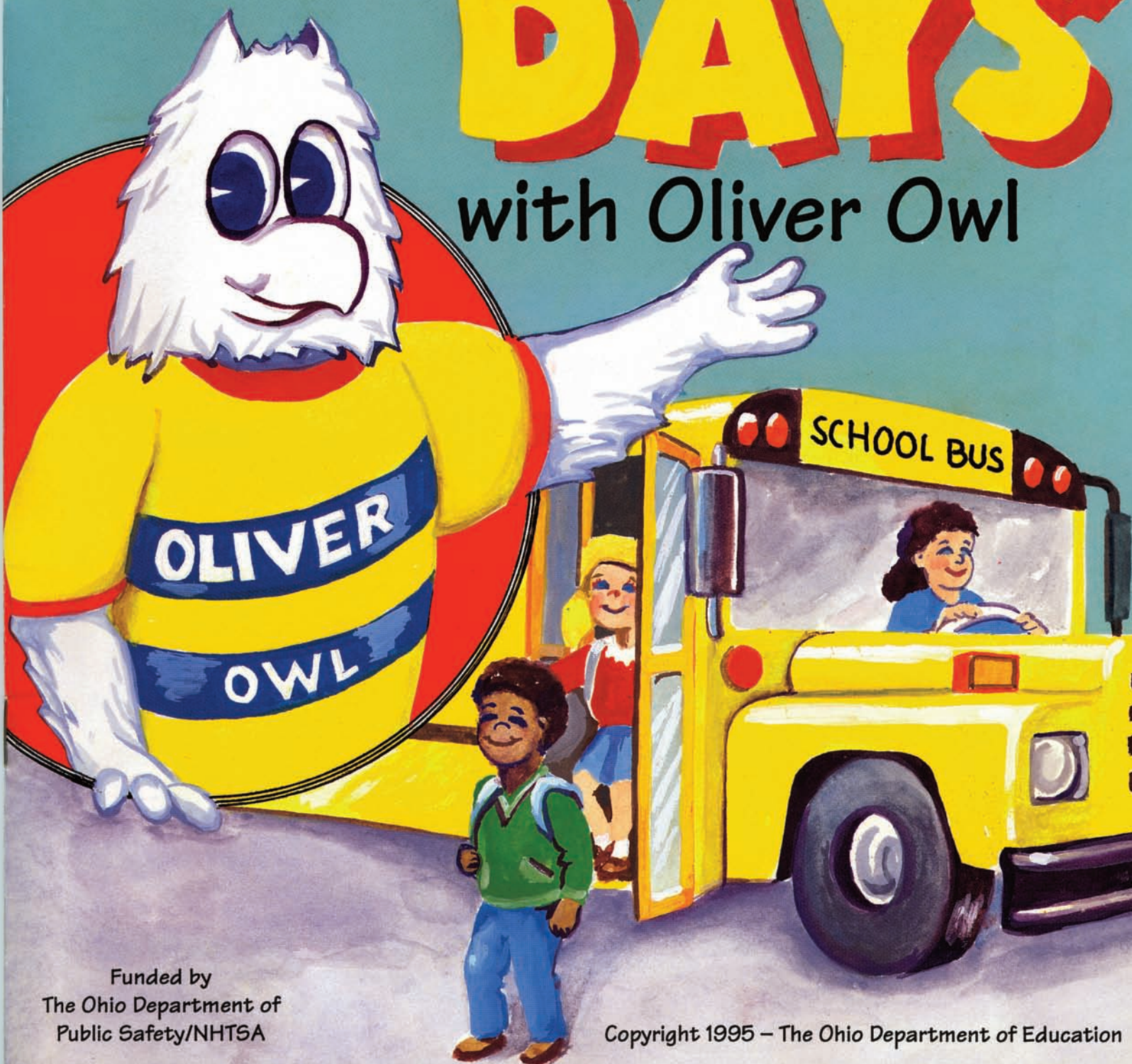

Funded by
The Ohio Department of
Public Safety/NHTSA

Copyright 1995 - The Ohio Department of Education



A letter to parents
from
Susan Tave Zelman,
Superintendent of
Public Instruction

State of Ohio
Department of Education
Columbus 43215-4183



Dear Parent:

This booklet is designed to assist K-3 pupils in learning about their role and responsibilities in pupil transportation safety. Parents also have a responsibility, and we seek your assistance to help insure that the daily ride to and from school is as safe as possible.

1. Give particular attention to the procedure children are to follow when crossing the roadway in front of the school bus. (This is the Danger Zone, pages 8-9).
2. See that your child is appropriately dressed during inclement weather and always arrives at the bus stop on time.
3. Become familiar with, and reinforce the school district rules and procedures at the school bus stops.
4. Reinforce the school district rules for pupils riding the bus.
5. Become familiar with the walking route to and from the school bus stop.

The help you give in recognizing the dangers inherent in pupil transportation will result in greater safety for each school bus passenger.

Sincerely,

Susan Tave Zelman
Superintendent of Public Instruction

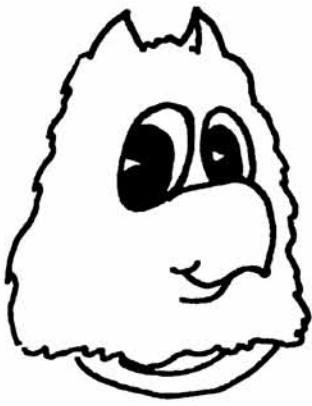

Oliver, the School Bus Safety Owl, wants you to be safe on your way TO and FROM school each day. He has some good rules for you to remember about School Bus Safety that can make all your School Days, SAFE DAYS.

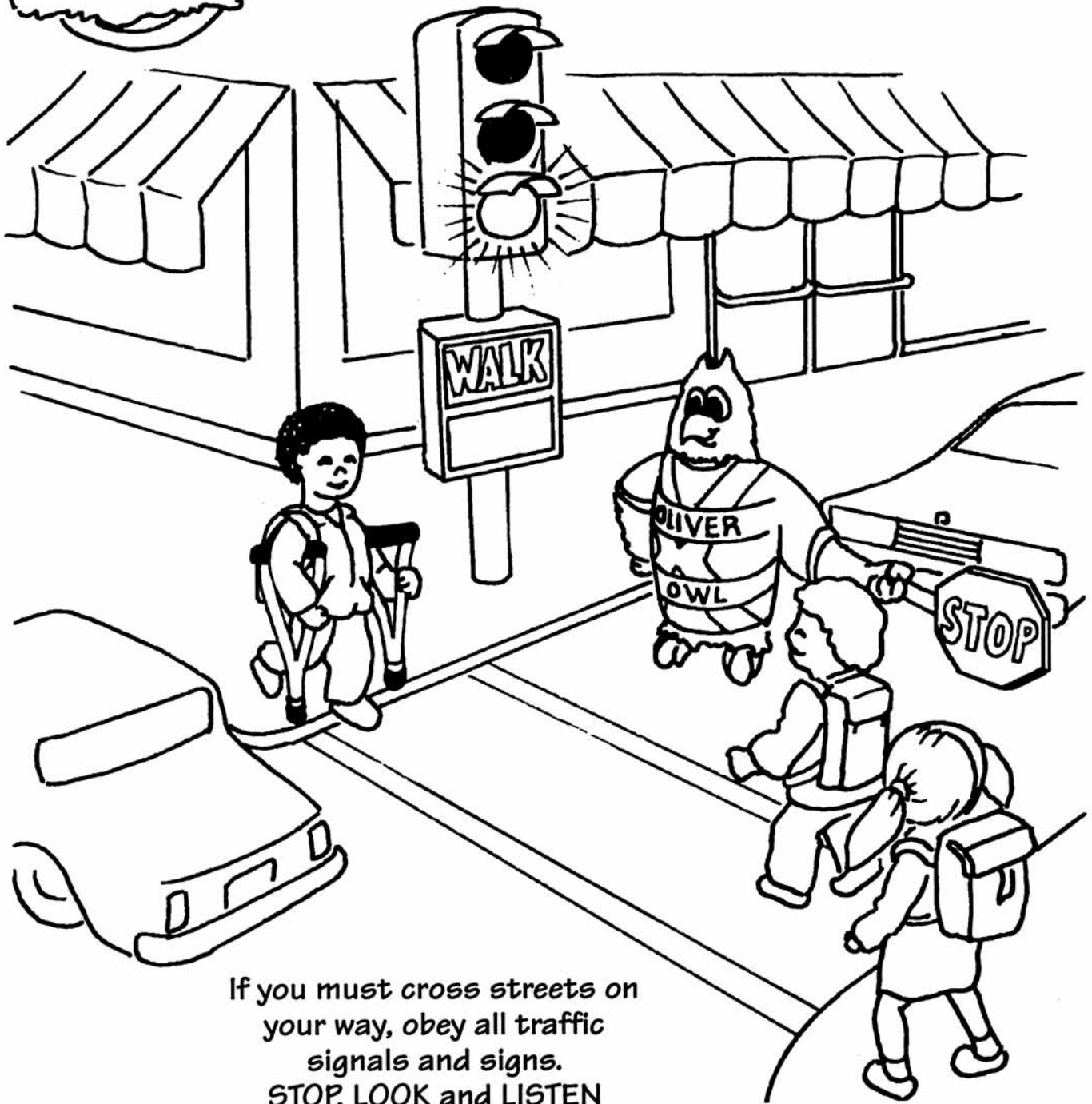

If you must cross streets on your way, obey all traffic signals and signs. STOP, LOOK and LISTEN before crossing.

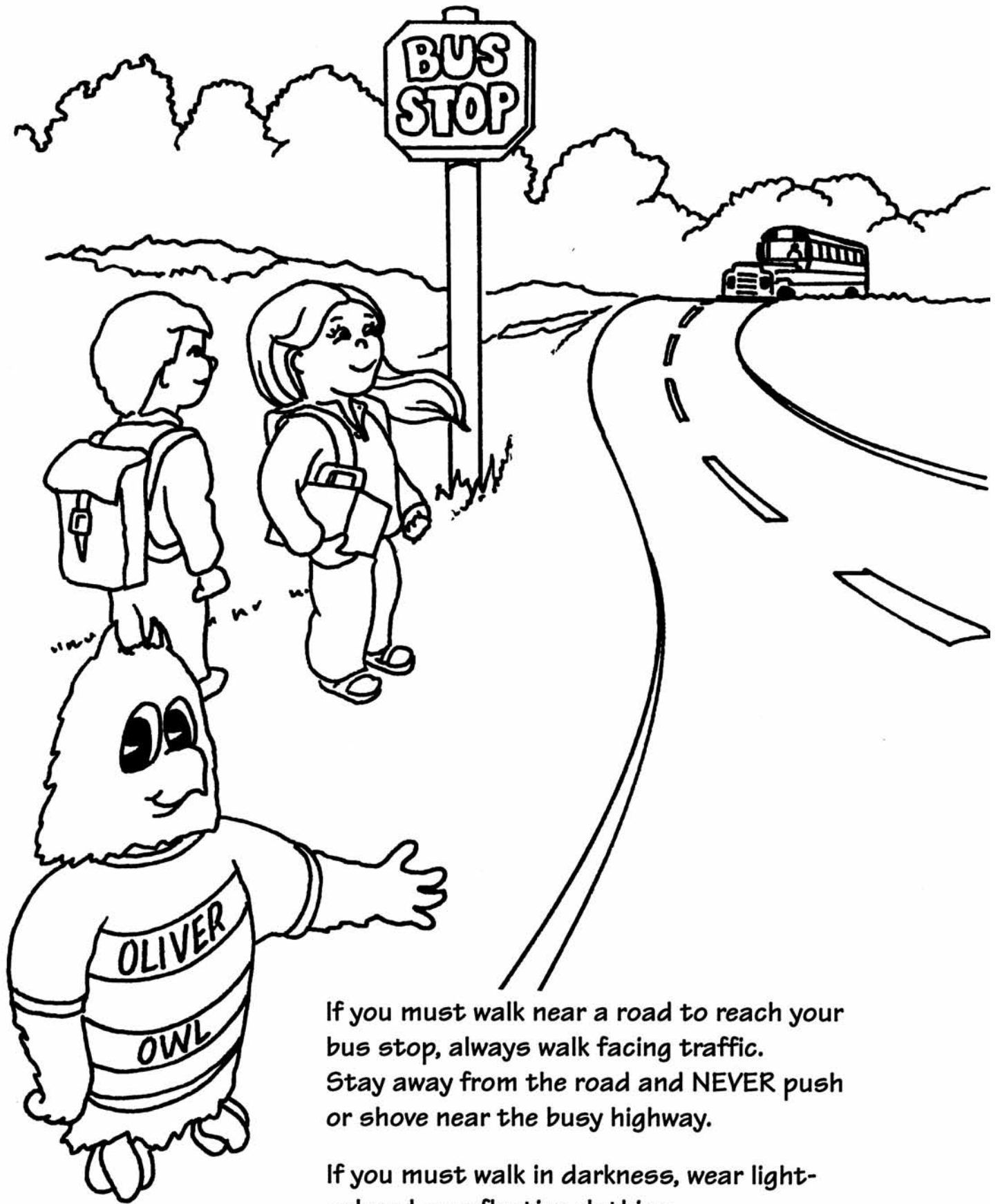

If you must walk near a road to reach your bus stop, always walk facing traffic. Stay away from the road and NEVER push or shove near the busy highway.

If you must walk in darkness, wear light-colored or reflective clothing.



Oliver says **BE WISE.**
Go directly to your bus.
Don't play along the way and
NEVER TALK TO STRANGERS.



Don't Take a Ride



Don't Take a Walk

Don't Take Gifts



Don't Even Stop to Talk



Tell someone you know and trust, if any of these things happen to you.
Try to remember what the stranger looks like.
If the person has a car, describe it, too.



Show what time you should be at your bus stop.

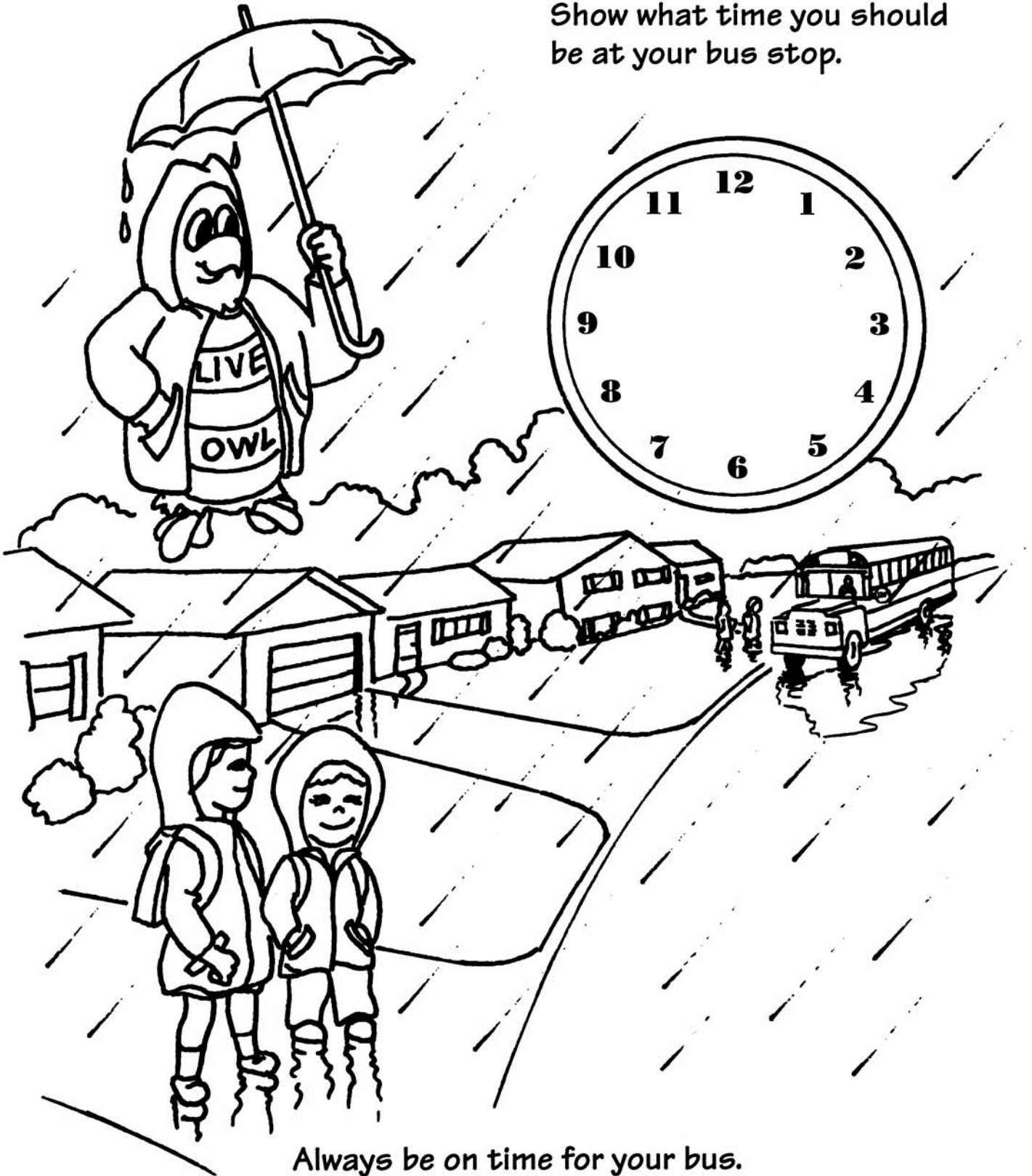

Always be on time for your bus.
The bus will not wait.
Be sure to dress properly for the weather.

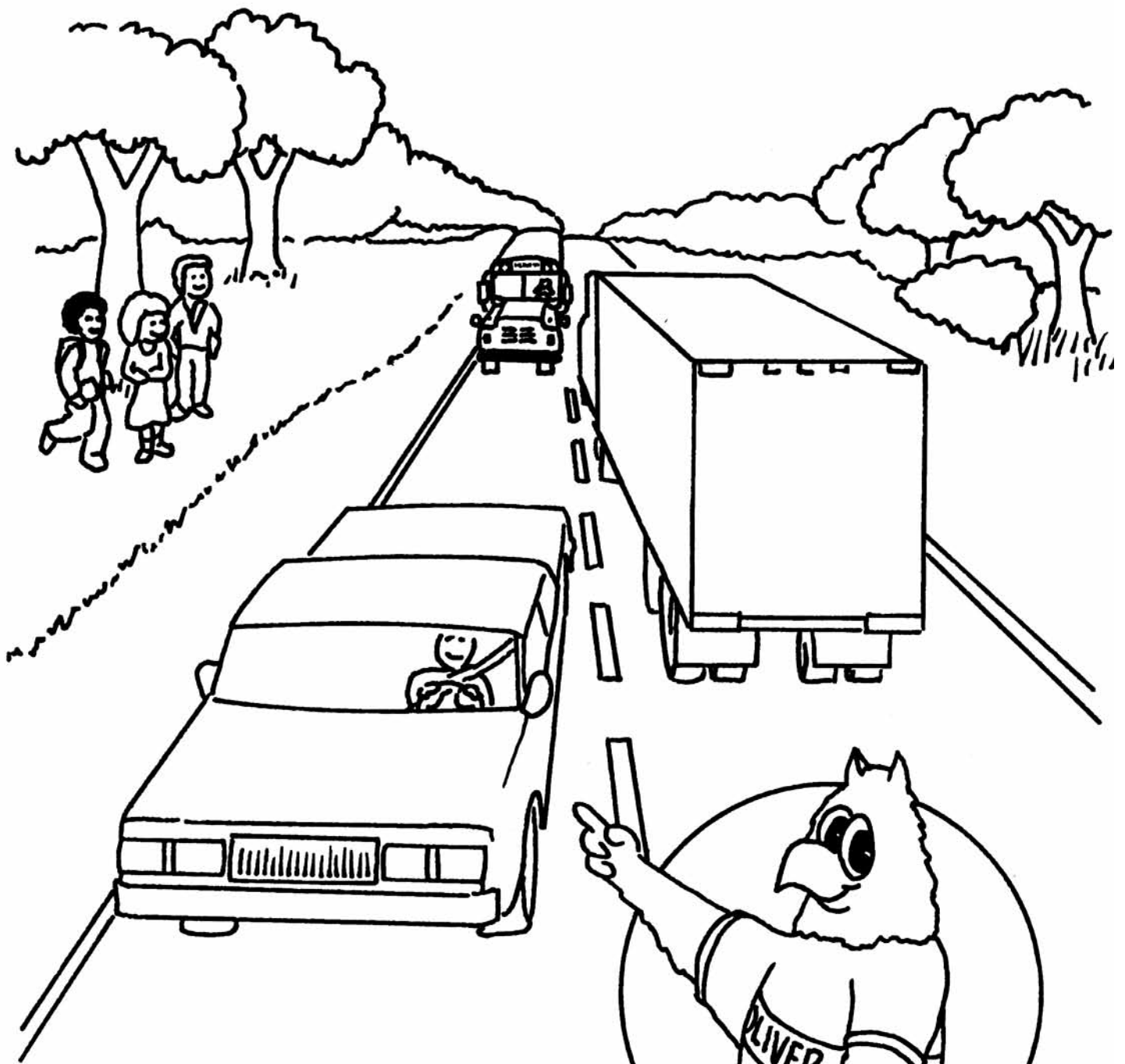

Always wait for your bus in a safe place. Standing near the street or highway can be very dangerous.

Be sure to wait, even if your bus is late. Go directly home if it does not arrive after you wait awhile.



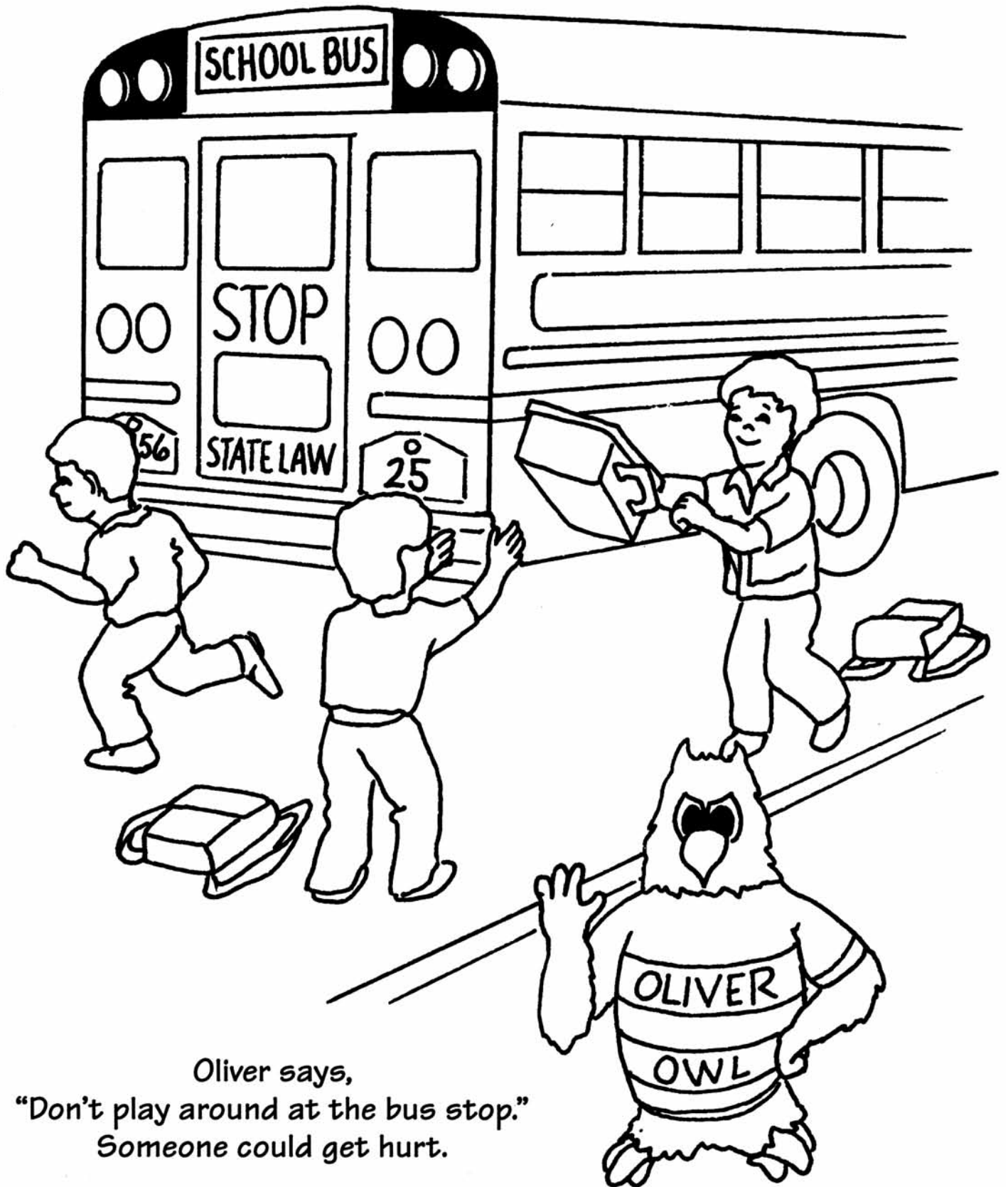

Oliver says,
"Don't play around at the bus stop."
Someone could get hurt.

If you drop something under the bus,
LEAVE IT.

Tell your bus driver or another adult.

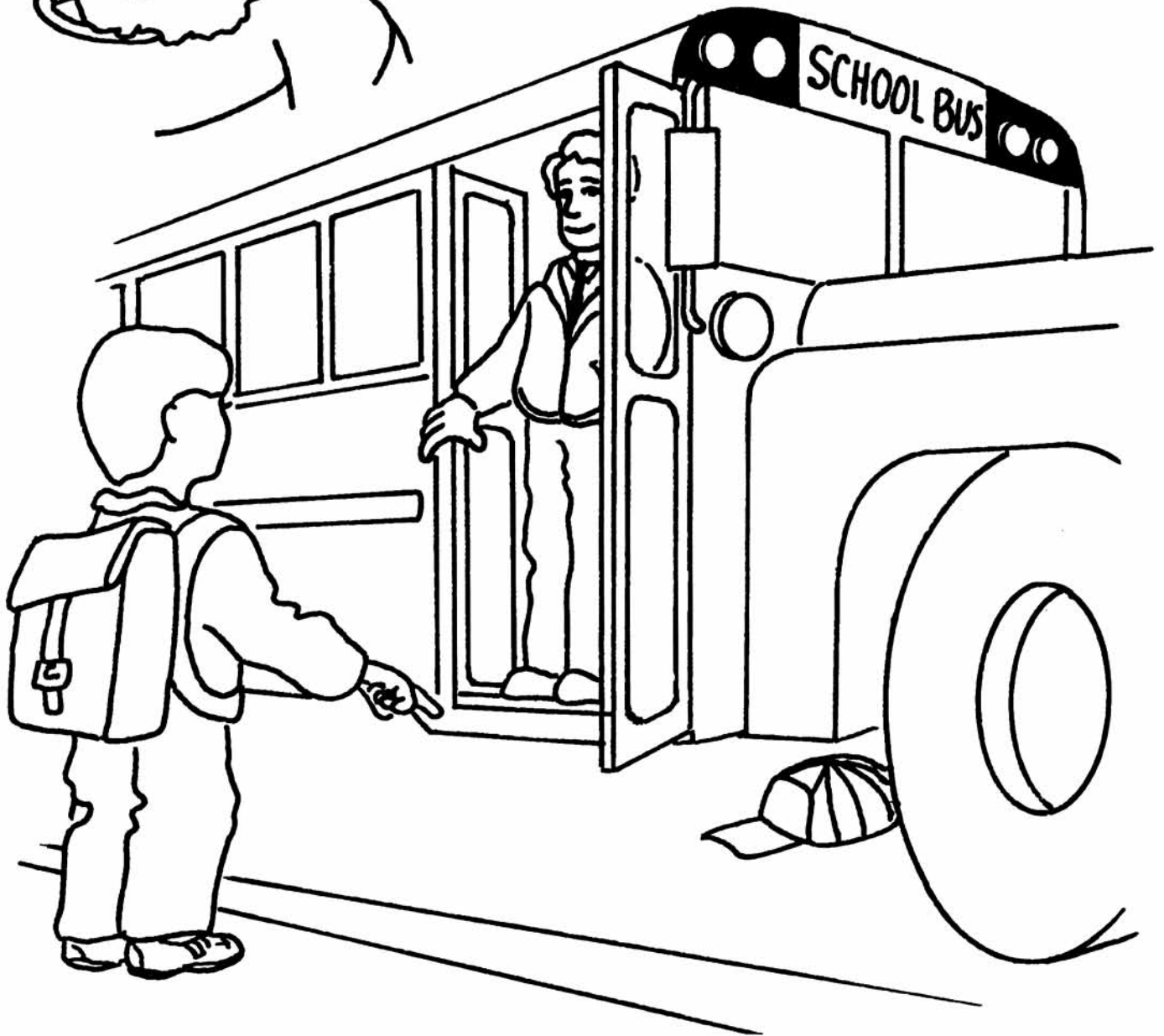

Be very careful in the DANGER ZONE around the school bus – especially around the wheels. Your bus driver CANNOT see you there.

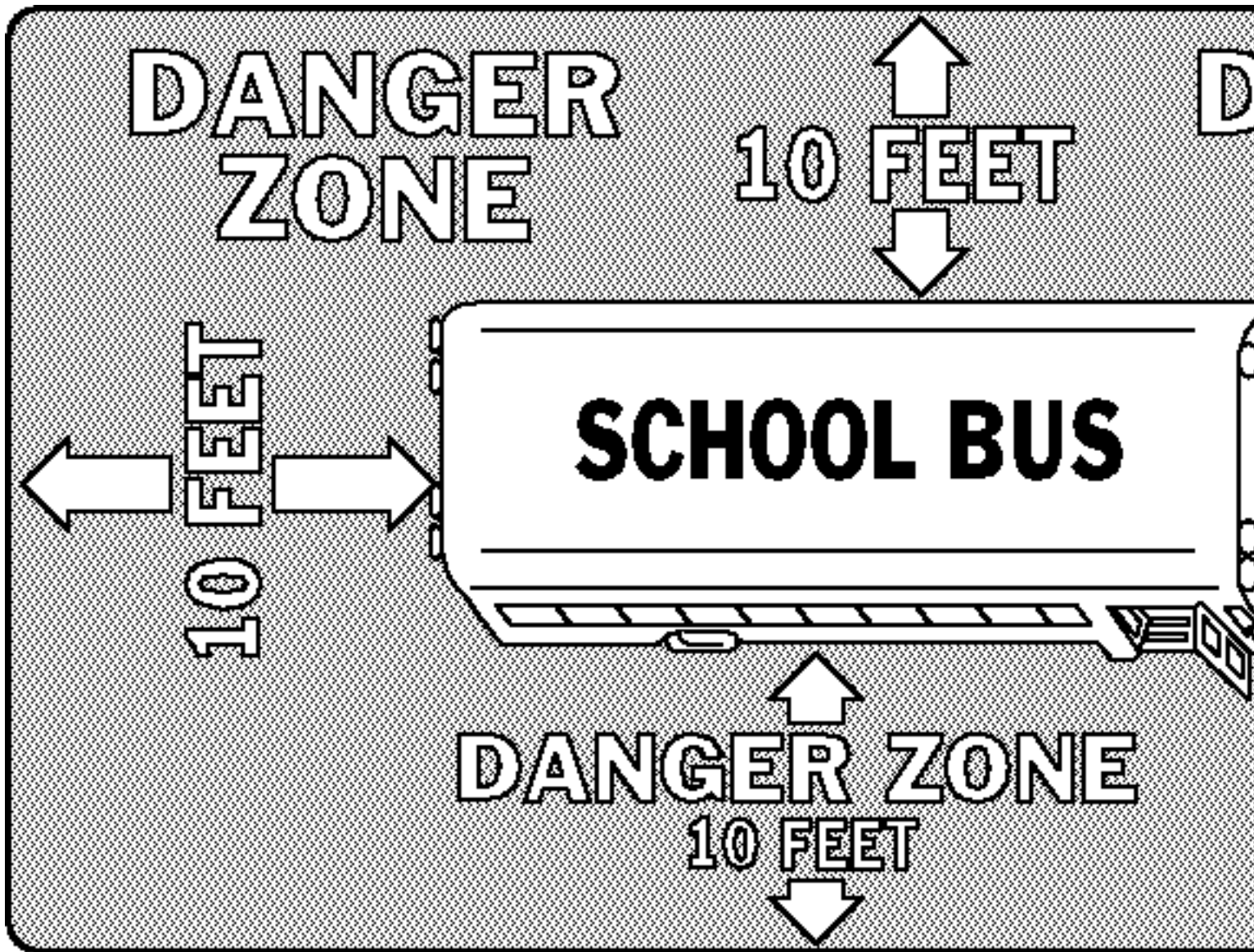

Always stay 10 GIANT STEPS in front of the bus.
The driver CAN see you there. NEVER walk behind the bus.

Color the Danger Zone red.

Color the Giant S

**DANGER
ZONE**

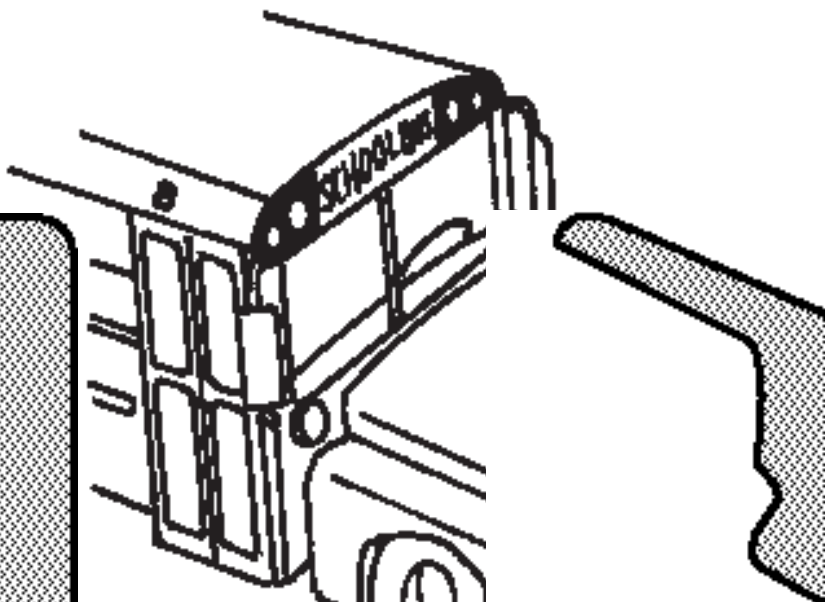
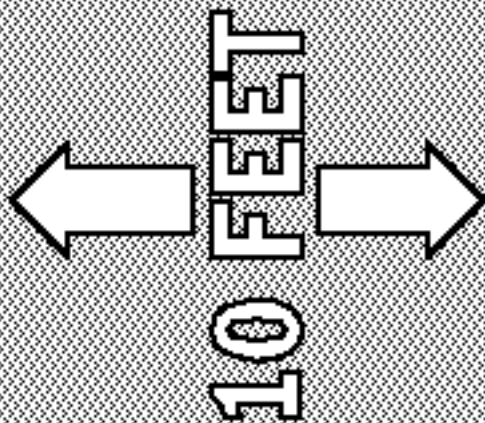
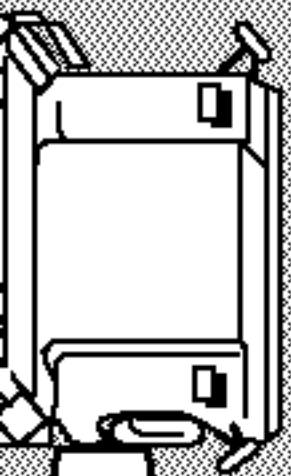

10 Giant Steps



steps yellow.

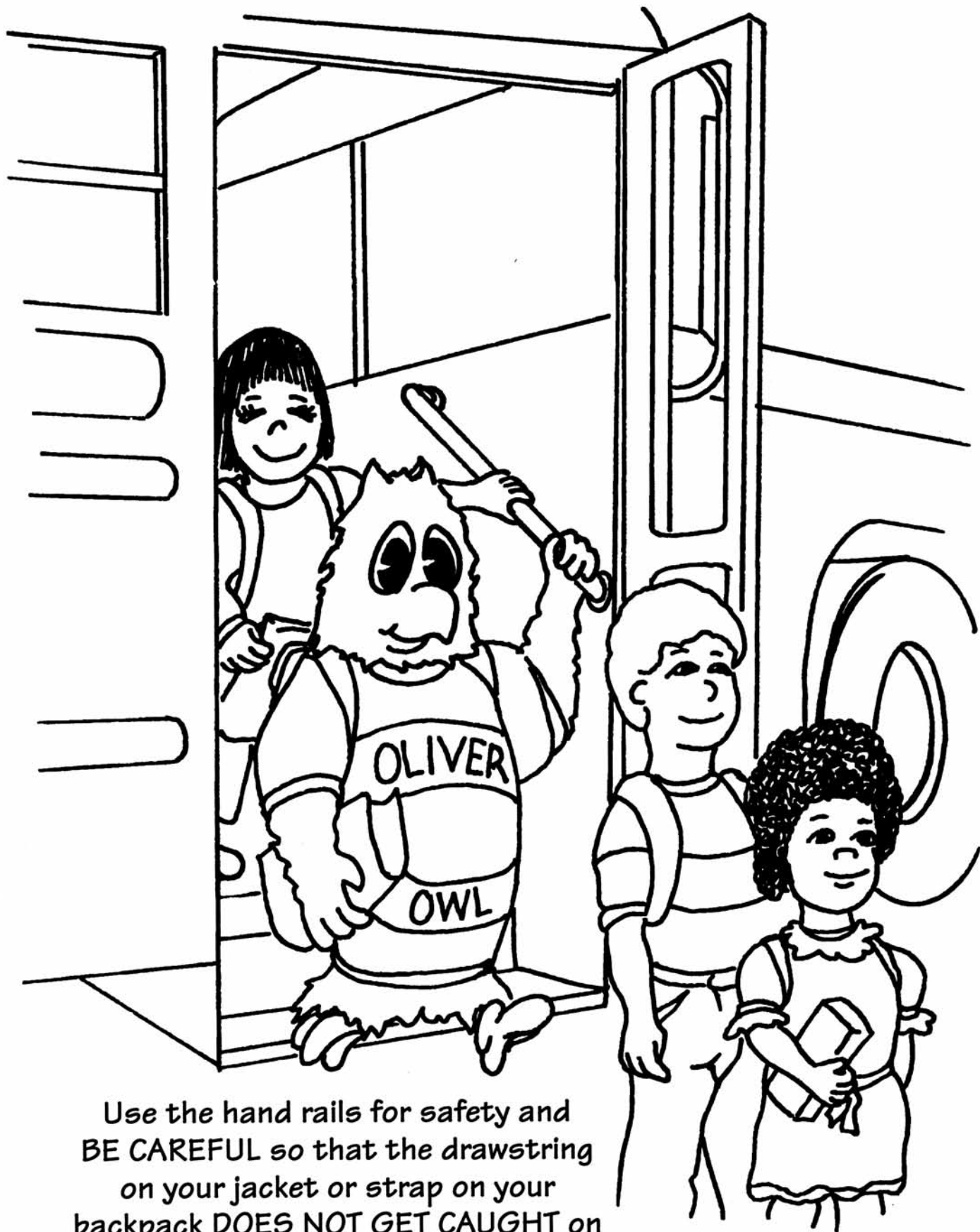

Use the hand rails for safety and
BE CAREFUL so that the drawstring
on your jacket or strap on your
backpack **DOES NOT GET CAUGHT** on
the handrail or door of the bus.

Remember, if you must cross in front of
of your bus:

1. STOP, LOOK, and LISTEN.
2. Take 10 Giant Steps in front of the bus.
3. Make eye contact – you can see your driver and your driver can see you.
4. Wait for the driver to signal when it's safe to cross.

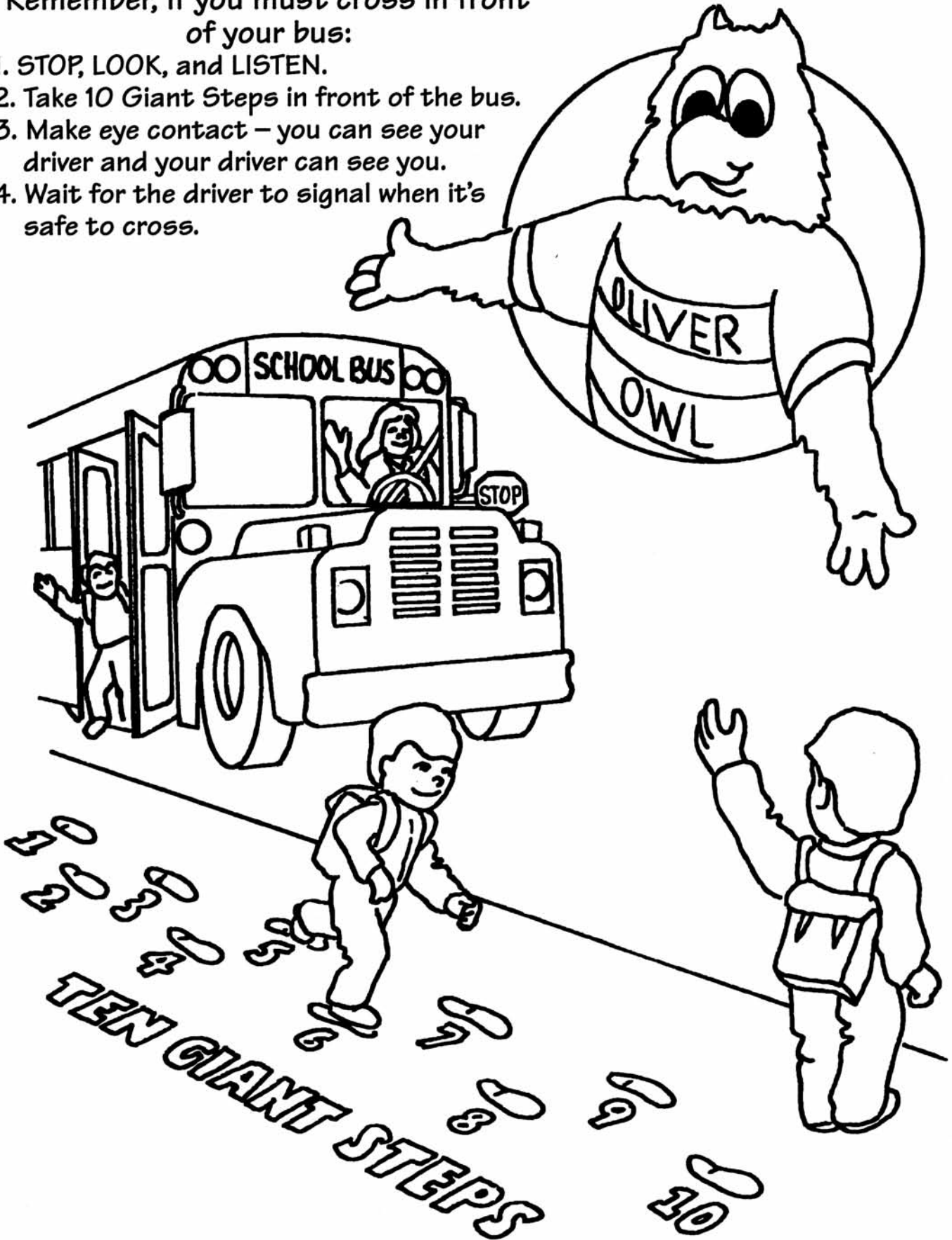

The School Bus Driver is your friend, whose job is to get you safely to school and back home. You can help to make your driver's job easier by learning safe riding rules.



SAFE RIDING RULES TO REMEMBER

- Always obey your driver.
- Go directly to your seat and remain seated.
- Keep aisles and exits clear.
- Keep head and arms inside the bus.
- Ride quietly.
- Keep your things on your lap.
- No eating or drinking on the bus.
- Don't use bad language.
- Be polite to others.



DO NOT DISTRACT
YOUR DRIVER

Circle the eight things wrong
in the above picture.

1. Boy throwing paper airplane
2. Girl turned around, hanging over the seat
3. Boy with head and arms out of the window
4. Lunch box in the aisle
5. Boy yelling
6. Girl eating a candy bar
7. Boy with feet in the aisle
8. Boy standing



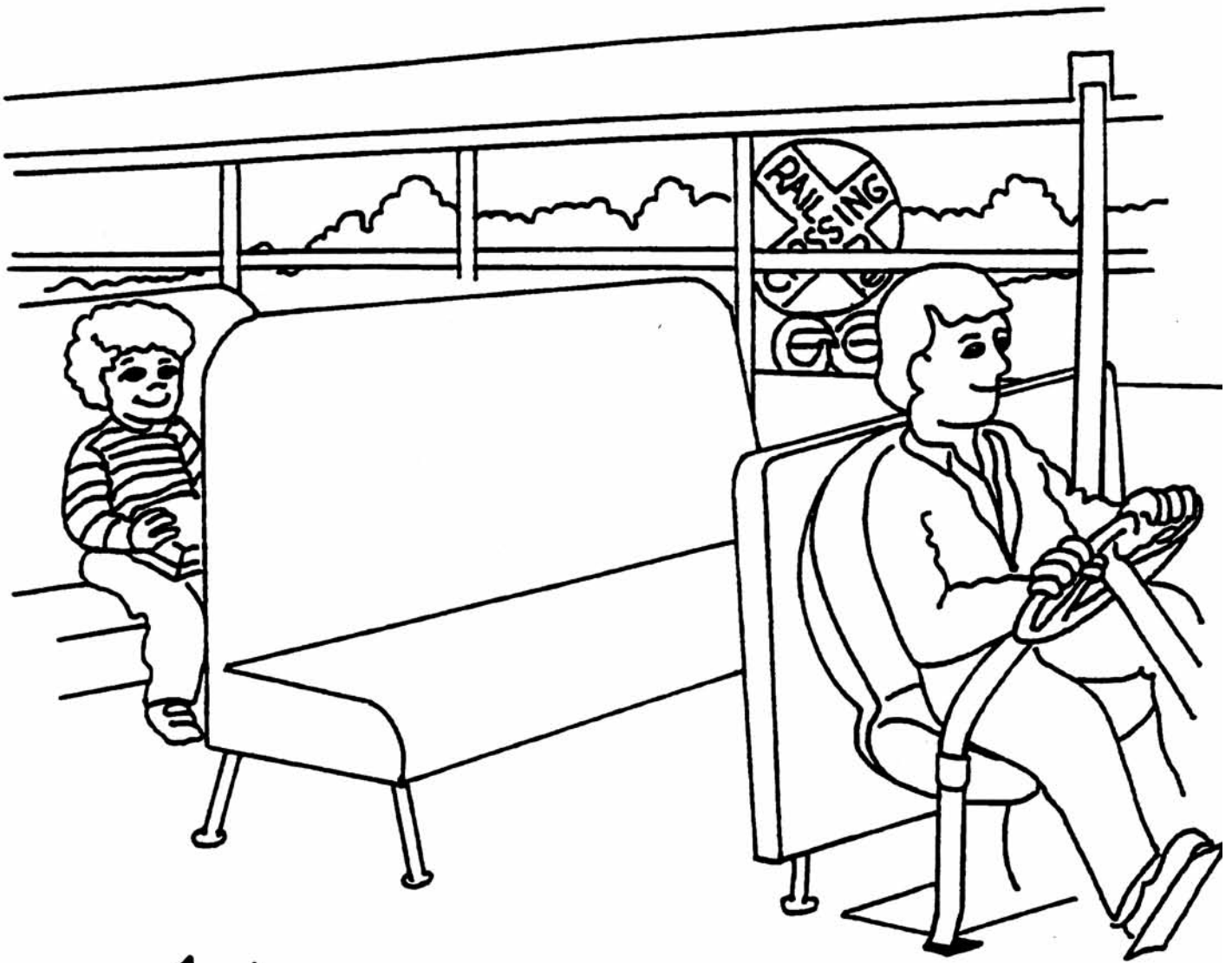

For everybody's safety, be **COMPLETELY QUIET** at railroad crossings. Watch for your driver's signal to be quiet. Draw yourself and a friend sitting quietly in the empty seat.

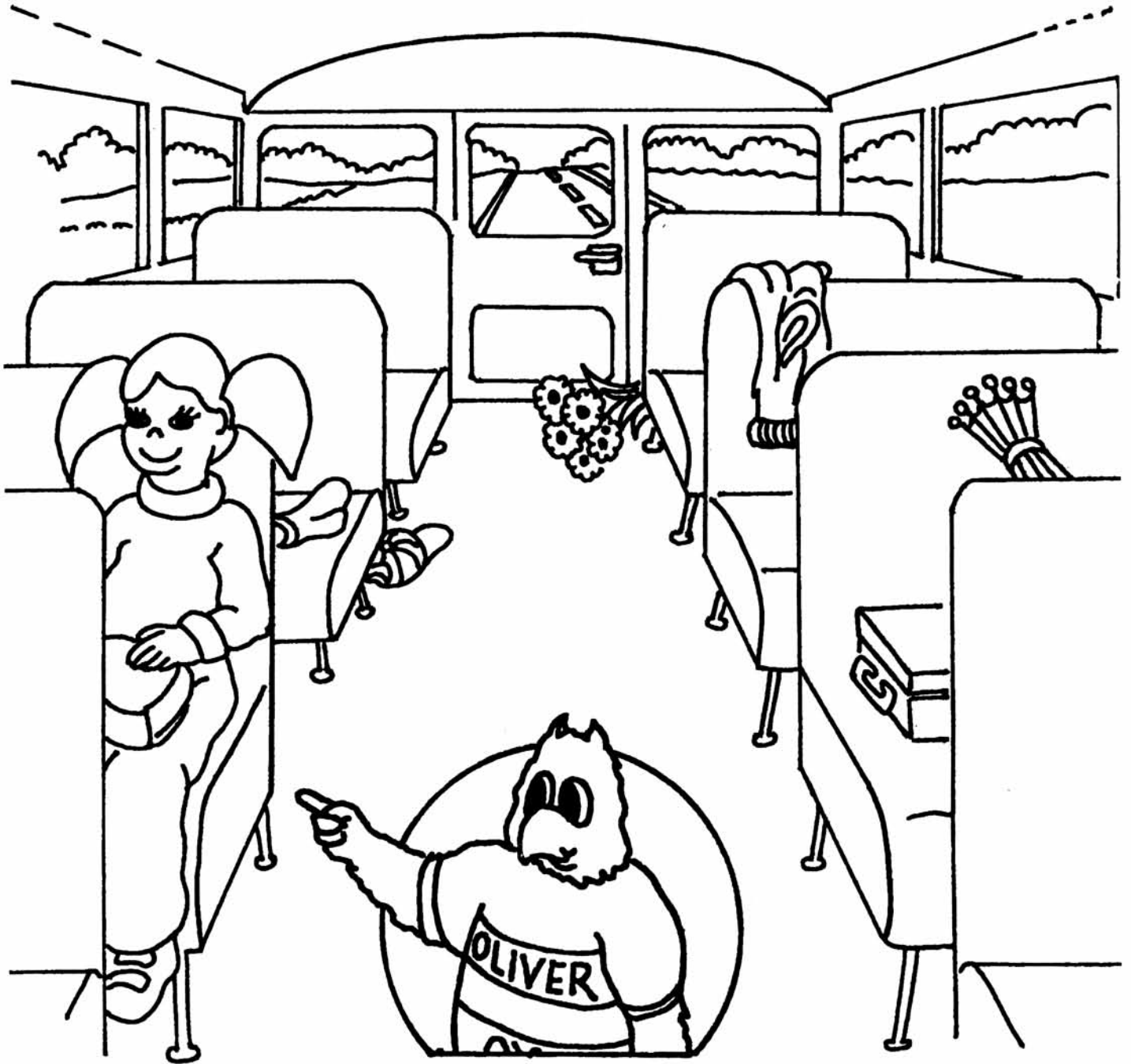

Always keep your belongings on your lap so that you do not leave them behind. This will make your driver happy.
Help find the things the children leave behind.

After school be sure to get off at
YOUR bus stop. Go directly home.
Don't play along the way.

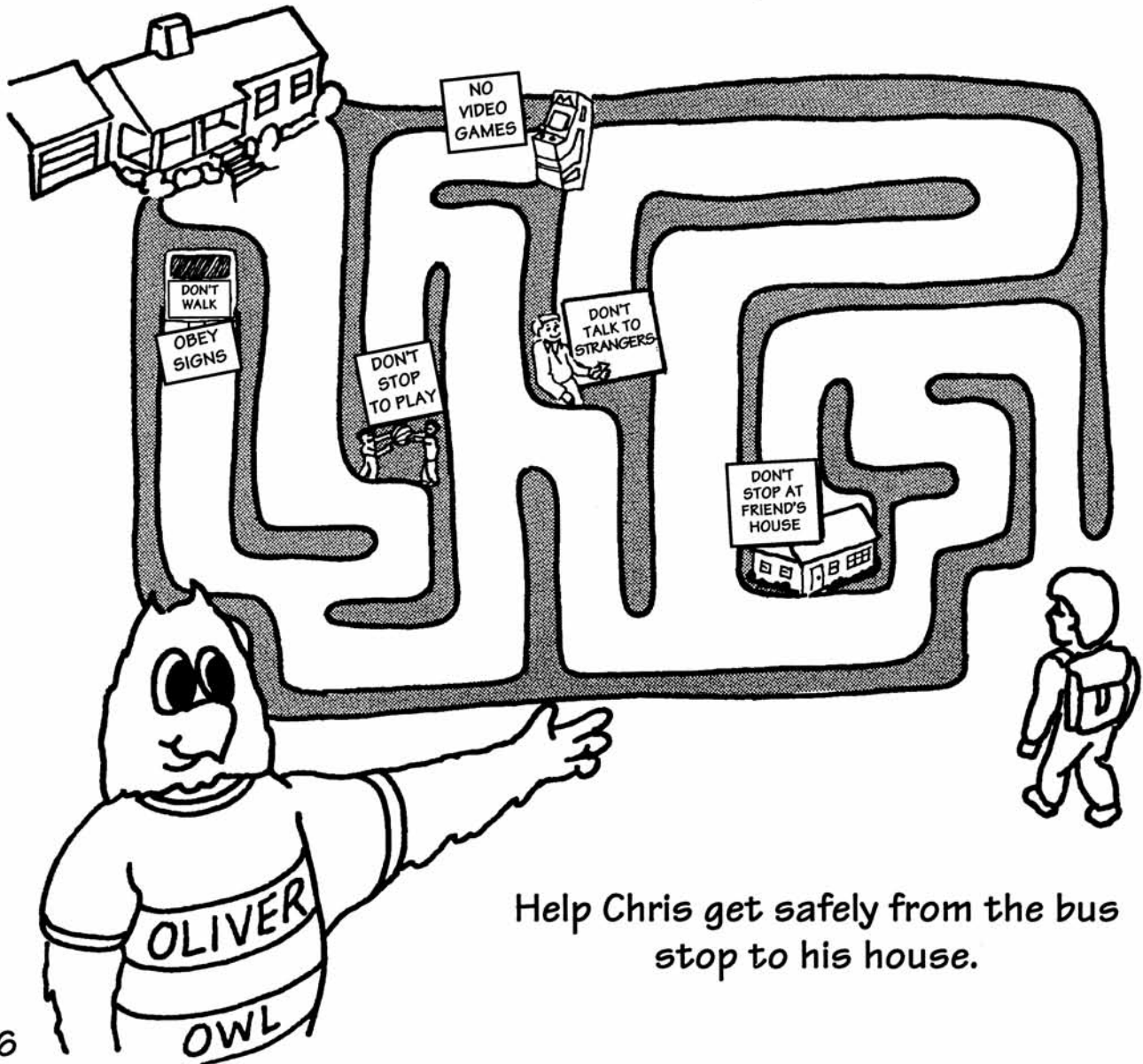
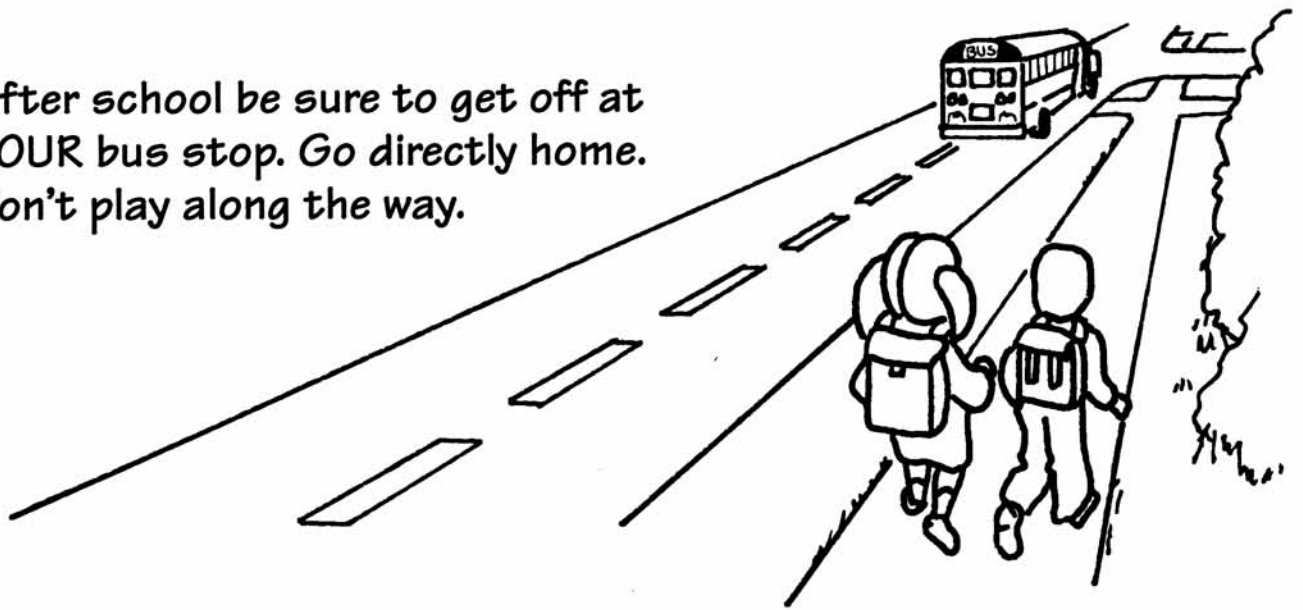

Help Chris get safely from the bus
stop to his house.

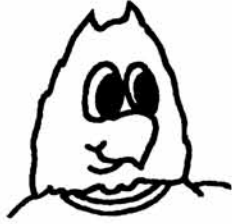

THE SAFE SCHOOL BUS RIDER'S PLEDGE

I promise to obey all the school bus riding rules in this book and to do my best to promote school bus safety in the State of Ohio.

Name _____

School _____ Bus No. _____

Address _____

_____ Date _____



This book was produced by
The Ohio Department of Education

Susan Tave Zelman
Superintendent of Public Instruction

Pete Japikse
Associate Director
Office of Pupil Transportation

Originally created by
Stephens Publishing Company
Sandusky, Ohio 44870
Artwork by Mark Brown